



1.4.9

Dachventilatoren



für gewerblichen und industriellen Einsatz

Serie TRM und TRT horizontal oder vertikal ausblasend



TRM..E und TRT..E



TRM..E-V und TRT..E-V

- Gehäuse aus verzinktem Stahlblech mit Epoxydharzlackierung
- selbstreinigendes, rückwärts gekrümmtes Aluminiumlaufrad mit Aluminiumdruckgussnabe
- Transportösen zum sicheren Transport an den Montageort
- strömungstechnisch optimierte Einströmdüse
- Motor mit thermischen Überlastungsschutz
- Schutzart IP55
- Drehstrommodelle mit 2-stufigem Motor, Stufenschaltung über optionalen Schalter
- zur sicheren Befestigung ist das Gerät mit einem Sicherheitsseil ausgestattet, das an der Tragekonstruktion befestigt werden kann
- Ausführungsformen:

TRM..E und **TRT..E** mit horizontaler Ausblasung

TRM..E-V und **TRT..E-V** mit vertikaler Ausblasung

Modelle TRM ...		10E 4P	15E 4P	20E 4P	30E 4P	50E 4P	70E 4P
Art. Nr.		15115	15205	15216	15356	15556	15070
Preis		394,80	414,60	542,80	588,90	685,80	1.383,10
Modelle TRM ...		10E-V 4P	15E-V 4P	20E-V 4P	30E-V 4P	50E-V 4P	70E-V 4P
Art. Nr.		15180	15182	15197	15198	15199	15188
Preis		544,80	538,90	705,60	765,60	857,20	1.728,90
Fördermenge	m³/h	1100	1400	2600	3300	4800	6400
max. Druck	Pa	216	255	353	432	380	662
Spannung 50 Hz	V	230	230	230	230	230	230
Nennstrom	A	0,50	0,70	1,30	1,80	3,70	4,35
Leistungsaufnahme	W	100	150	280	400	800	1000
Drehzahl	U/min	1400	1400	1415	1425	1480	1415
Schallpegel (3 m)	dB(A)	56	58,5	62	67	72,5	77
Fördertemperatur	°C	90	80	85	70	80	90

Modelle TRT ...		10E 4P	15E 4P	20E 4P	30E 4P	50E 4P	70E 4P	70E 6P
Art. Nr.		15155	15255	15215	15355	15555	15071	15072
Preis		400,70	408,50	510,10	560,60	635,10	1.330,50	1.425,90
Modelle TRT ...		10E-V 4P	15E-V 4P	20E-V 4P	30E-V 4P	50E-V 4P	70E-V 4P	70E-V 6P
Art. Nr.		15181	15183	15184	15185	15186	15187	15189
Preis		552,90	531,10	663,10	728,80	793,90	1.663,10	1.782,40
Fördermenge	m³/h	1100	1400	2700	3200	4900	6400	7000
max. Druck	Pa	216	255	343	451	598	677	373
Spannung 50 Hz	V	3x400	3x400	3x400	3x400	3x400	3x400	3x400
Nennstrom	A	0,30	0,30	0,60	0,75	1,45	1,85	1,30
Leistungsaufnahme	W	100	150	300	400	800	950	600
Drehzahl	U/min	1400	1400	1400	140	1400	1440	950
Schallpegel (3 m)	dB(A)	56	58,5	62	67	72,5	77	74
Fördertemperatur	°C	90	90	90	90	90	90	90

Modelle TRT ...		100E 4P	100E 6P	100E 8P	150E 6P	150E 8P	180E 6P	210E 6P
Art. Nr.		15073	15074	15075	15076	15077	15078	15079
Preis		1.386,30	1.829,70	2.017,10	1.979,60	2.216,90	2.325,80	2.488,60
Modelle TRT ...		100E-V 4P	100E-V 6P	100E-V 8P	150E-V 6P	150E-V 8P	180E-V 6P	210E-V 6P
Art. Nr.		15190	15191	15192	15193	15194	15195	15196
Preis		1.732,90	2.287,10	2.521,30	2.474,50	2.771,10	2.791,00	2.986,40
Fördermenge	m³/h	10000	10800	11000	15000	15000	16000	15000
max. Druck	Pa	829	471	334	598	441	775	775
Spannung 50 Hz	V	3x400	3x400	3x400	3x400	3x400	3x400	3x400
Nennstrom	A	3,25	2,30	2,10	3,45	3,10	5,95	6,40
Leistungsaufnahme	W	1900	1100	930	1930	1600	3100	3400
Drehzahl	U/min	1420	950	715	930	715	970	980
Schallpegel (3 m)	dB(A)	84	77	71	80	74	83	84
Fördertemperatur	°C	70	85	80	80	75	80	70

Dachventilatoren

1.4.9



Abmessungen

NEU

TRM..E und TRT..E mit horizontaler Ausblasung

Abmessungen

Modell	∅ A	□ B	□ C	D	E	F	G	H	∅ L	kg
TRM 10 E 4P	600	410	357	310	108	38	26,5	456	170	14,5
TRM 15 E 4P	600	410	357	310	108	38	26,5	456	182	15
TRM 20 E 4P	780	550	500	398	128	38	25	564	219	22
TRM 30 E 4P	780	550	500	398	146	38	25	582	244	23
TRM 50 E 4P	780	550	500	398	173	38	25	609	278	28
TRM 70 E 4P	1015	830	750	449	283	38	40	770	328	79
TRT 10 E 4P	600	410	357	310	108	38	26,5	456	170	14,5
TRT 15 E 4P	600	410	357	310	108	38	26,5	456	182	15
TRT 20 E 4P	780	550	500	398	128	38	25	564	219	22
TRT 30 E 4P	780	550	500	398	146	38	25	582	244	23
TRT 50 E 4P	780	550	500	398	173	38	25	609	278	28
TRT 70 E 4P	1015	830	750	449	283	38	40	770	328	77
TRT 70 E 6P	1015	830	750	449	283	38	40	770	365	80
TRT 100 E 4P	1015	830	750	449	283	38	40	770	365	81
TRT 100 E 6P	1165	980	900	605	383	38	40	1026	415	117
TRT 100 E 8P	1165	980	900	605	383	38	40	1026	465	127
TRT 150 E 6P	1165	980	900	605	383	38	40	1026	465	128
TRT 150 E 8P	1165	980	900	605	383	38	40	1026	520	132
TRT 180 E 6P	1165	980	900	605	383	38	40	1026	520	130
TRT 210 E 6P	1165	980	900	605	383	38	40	1026	520	130

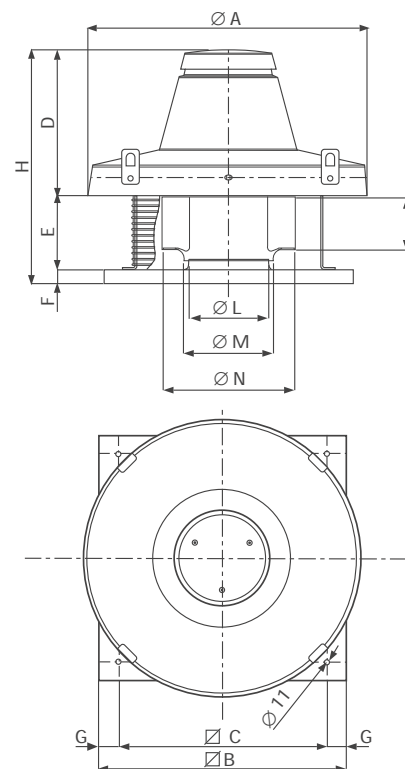

TRM..EV und TRT..EV mit vertikaler Ausblasung

Abmessungen

Modell	A	B	C	D	E	F	G	H	∅ L	∅ Q	kg
TRM 10 E-V 4P	652	410	357	440	328	38	26,5	502	170	11	23
TRM 15 E-V 4P	652	410	357	440	328	38	26,5	502	182	11	24
TRM 20 E-V 4P	907	550	500	580	432	38	25	586	219	11	43
TRM 30 E-V 4P	907	550	500	580	432	38	25	604	244	11	45
TRM 50 E-V 4P	907	550	500	580	432	38	25	631	278	11	51
TRM 70 E-V 4P	1144	830	750	860	491	38	40	723	328	12	105
TRT 10 E-V 4P	652	410	357	440	328	38	26,5	502	170	11	23
TRT 15 E-V 4P	652	410	357	440	328	38	26,5	502	182	11	24
TRT 20 E-V 4P	907	550	500	580	432	38	25	586	219	11	43
TRT 30 E-V 4P	907	550	500	580	432	38	25	604	244	11	45
TRT 50 E-V 4P	907	550	500	580	432	38	25	631	278	11	51
TRT 70 E-V 4P	1144	830	750	860	491	38	40	723	328	12	103
TRT 70 E-V 6P	1144	830	750	860	491	38	40	723	365	12	106
TRT 100 E-V 4P	1144	830	750	860	491	38	40	723	365	12	107
TRT 100 E-V 6P	1462	980	900	1010	595	38	40	903	415	12	161
TRT 100 E-V 8P	1462	980	900	1010	595	38	40	903	465	12	171
TRT 150 E-V 6P	1462	980	900	1010	595	38	40	903	465	12	172
TRT 150 E-V 8P	1462	980	900	1010	595	38	40	903	520	12	176
TRT 180 E-V 6P	1462	980	900	1010	595	38	40	905	520	12	174
TRT 210 E-V 6P	1462	980	900	1010	595	38	40	905	520	12	174

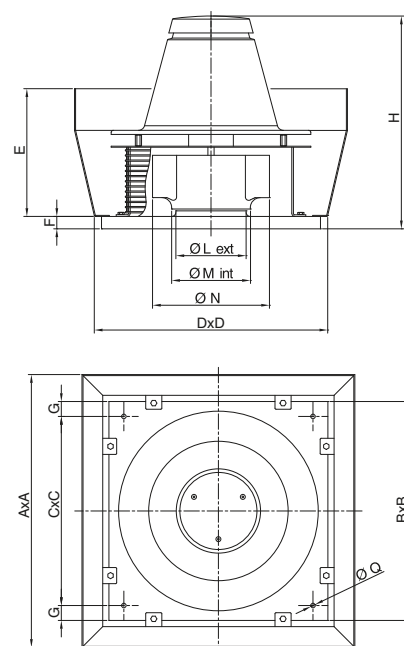



1.4.9

Dachventilatoren

Leistungsdiagramme

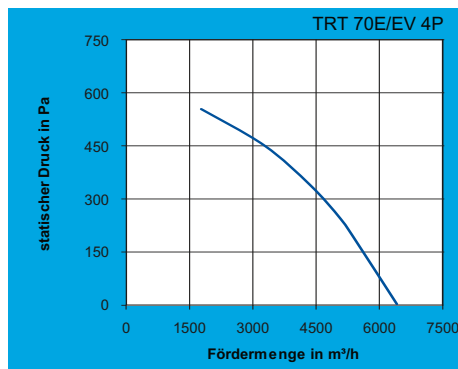
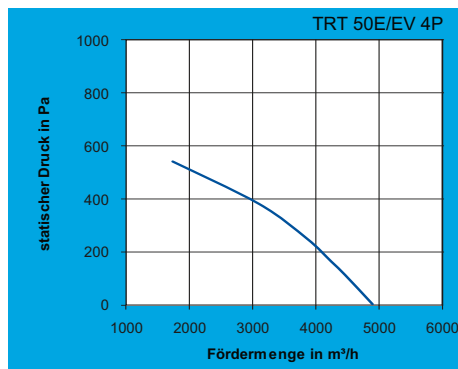
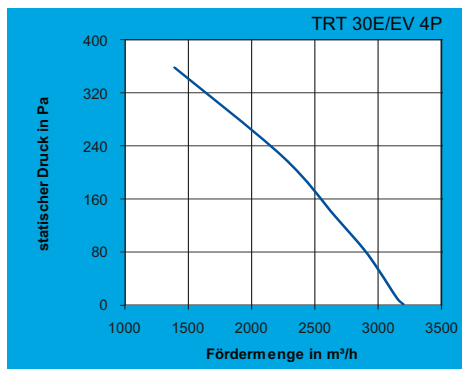
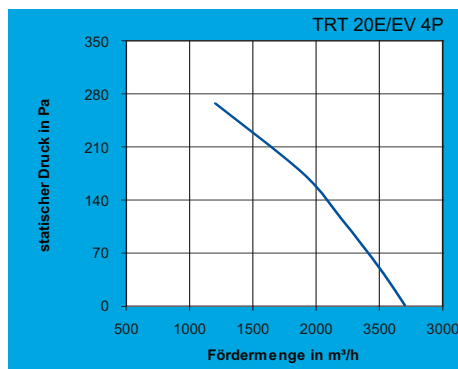
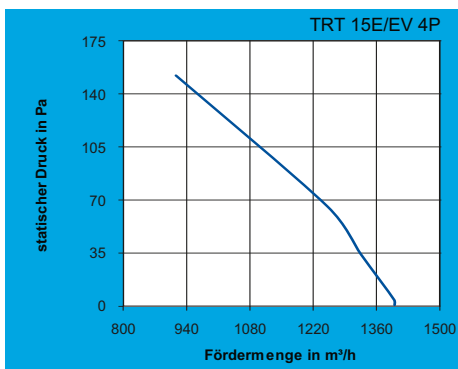
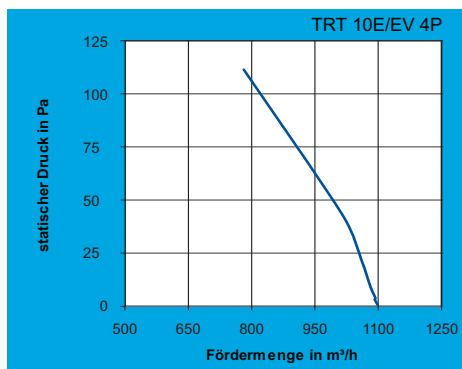
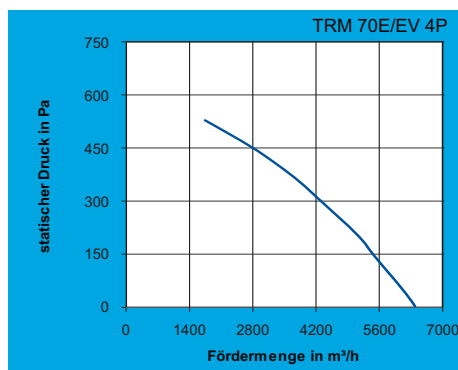
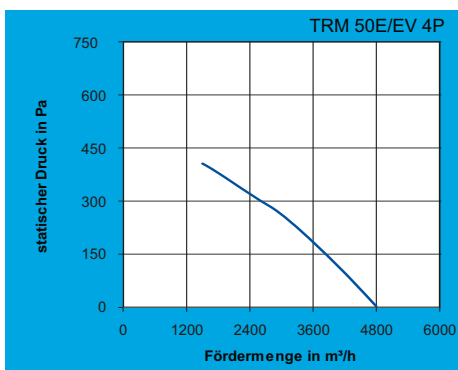
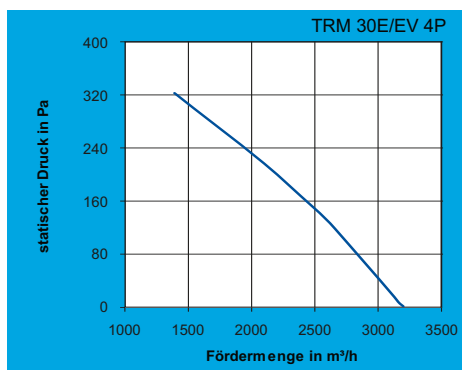
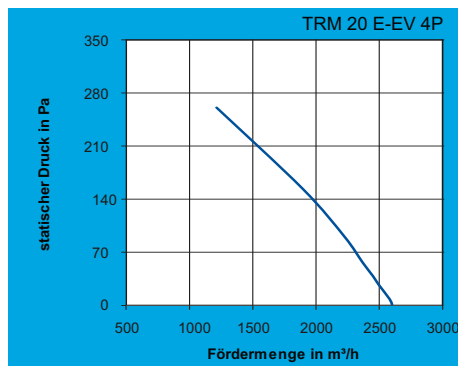
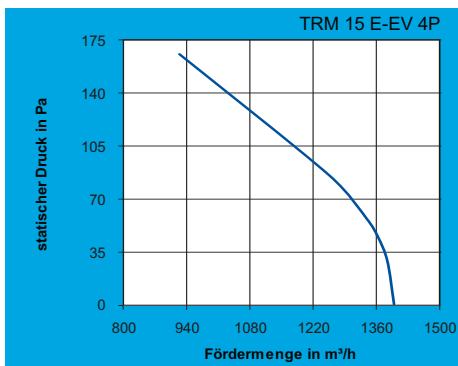
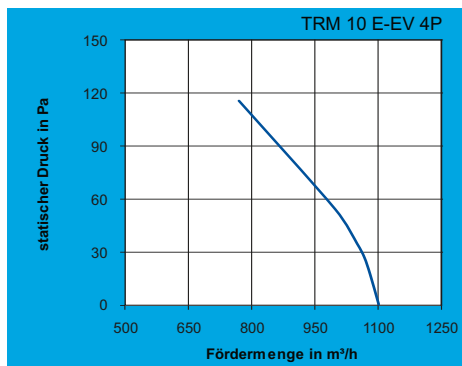

Dachventilatoren

1.4.9



für TRM...E, TRM...E-V, TRT...E und TRT...E-V

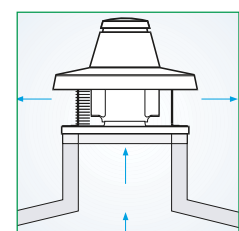
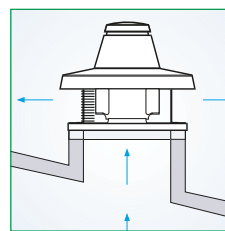
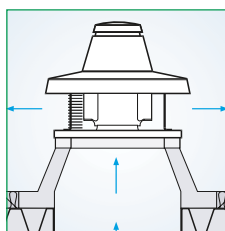
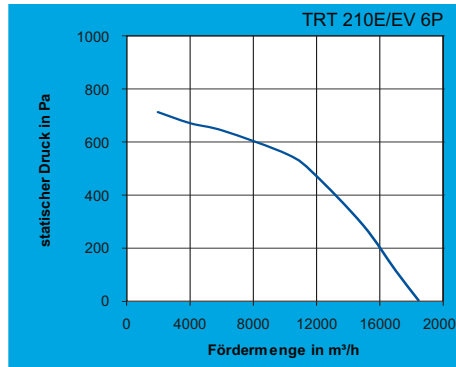
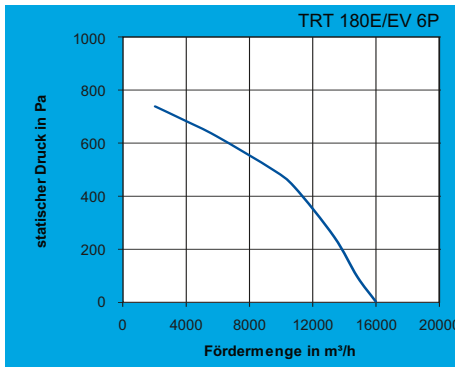
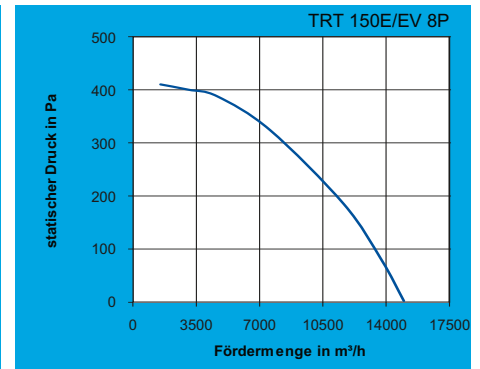
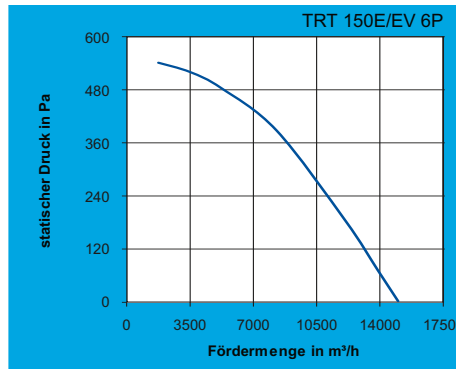
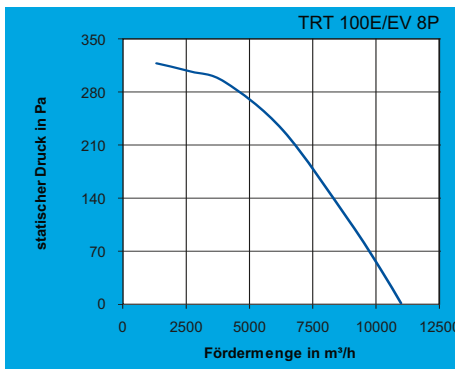
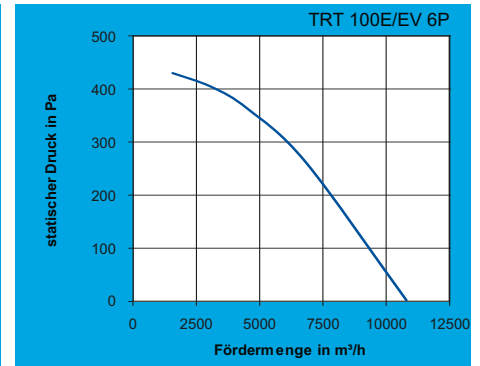
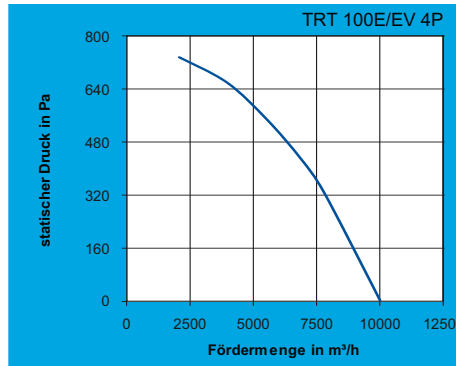
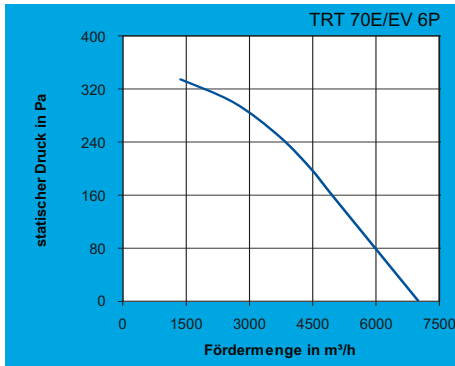



1.4.9

Dachventilatoren

Zubehör

für Serie TRM..E, TRM..E-V und TRT..E, TRT..E-V

Type	TRM 10 E 4P	TRT 10 E 4P	TRM 15 E 4P	TRT 15 E 4P	TRM 20 E 4P	TRT 20 E 4P	TRM 30 E 4P	TRT 30 E 4P	TRM 50 E 4P	TRT 50 E 4P
Grundrahmen Art. Nr. Preis	TR-CU 10/15 22511 40,80	TR-CU 10/15 22511 40,80	TR-CU 10/15 22511 40,80	TR-CU 10/15 22511 40,80	TR-CU 20/30/50 22512 44,40	TR-CU 20/30/50 22512 44,40	TR-CU 20/30/50 22512 44,40	TR-CU 20/30/50 22512 44,40	TR-CU 20/30/50 22512 44,40	TR-CU 20/30/50 22512 44,40
Schutzgitter saugseitig Art. Nr. Preis	TR-G 10/15 22700 12,80	TR-G 10/15 22700 12,80	TR-G 10/15 22700 12,80	TR-G 10/15 22700 12,80	TR-G 20/30/50 22710 17,20	TR-G 20/30/50 22710 17,20	TR-G 20/30/50 22710 17,20	TR-G 20/30/50 22710 17,20	TR-G 20/30/50 22710 17,20	TR-G 20/30/50 22710 17,20
Rückschlagklappe Art. Nr. Preis	TR-S 10/15 22500 71,60	TR-S 10/15 22500 71,60	TR-S 10/15 22500 71,60	TR-S 10/15 22500 71,60	TR-S 20/30/50 22510 85,00	TR-S 20/30/50 22510 85,00	TR-S 20/30/50 22510 85,00	TR-S 20/30/50 22510 85,00	TR-S 20/30/50 22510 85,00	TR-S 20/30/50 22510 85,00
Ansaugdüse Art. Nr. Preis	TR-B 10/15 22600 24,80	TR-B 10/15 22600 24,80	TR-B 10/15 22600 24,80	TR-B 10/15 22600 24,80	TR-B 20/30/50 22610 40,20	TR-B 20/30/50 22610 40,20	TR-B 20/30/50 22610 40,20	TR-B 20/30/50 22610 40,20	TR-B 20/30/50 22610 40,20	TR-B 20/30/50 22610 40,20
Drehzahlregler 3-stufig 1-phasig, 230 V / 50 Hz Art. Nr. Preis	IRM30 12921 267,90	- -	IRM30 12921 267,90	- -	IRM40 12922 320,60	- -	IRM40 12922 320,60	- -	IRM50 12928 296,90	- -
Drehzahlregler 3-stufig 3-phasig, 3x400 V / 50 Hz Art. Nr. Preis	- -	IRT15 12923 349,90	- -	IRT15 12923 349,90	- -	IRT15 12923 349,90	- -	IRT35 12924 419,20	- -	IRT35 12924 419,20
Drehzahlsteller elektronisch stufenlos Art. Nr. Preis	IREM3 12931 168,60	- -	IREM3 12931 168,60	- -	IREM3 12931 168,60	- -	IREM3 12931 168,60	- -	IREM5 12932 205,90	- -
Frequenzumformer* 3-phasig, 3x400 V / 50 Hz Art. Nr. Preis	- -	IRET INV1.2 12909 814,5	- -	IRET INV1.2 12909 814,5	- -	IRET INV1.2 12909 814,5	- -	IRET INV1.2 12909 814,5	- -	IRET INV2.2 12925 862,40

* auch als 230 V Version lieferbar (siehe Seite 235)

Ansaugdüse für TR..

	Art. Nr.	Preis	ØA	ØB	ØC
TR-B10/15	22600	24,80	225	254	275
TR-B20/30/50	22610	40,20	330	359	380
TR-B70/100	22508	161,80	430	500	480
TR-B100/150	22509	184,20	570	640	620

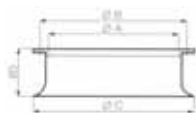

Grundrahmen für TR.. und TR..ED

	Art. Nr.	Preis	A	B
TR-CU 10/15	22511	40,80	357	401
TR-CU20/30/50	22512	44,40	500	541
TR-CU70/100	22539	49,60	750	791
TR-CU100/150	22540	54,00	900	941



Schutzgitter für TR.. und TR..ED Saugseitig

	Art. Nr.	Preis	ØA	ØB
TR-G10/15	22700	12,80	222	254
TR-G20/30/50	22710	17,20	318	359
TR-G70/100	22506	44,30	423	500
TR-G100/150	22507	55,50	563	640

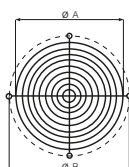

Rückschlagklappe für TR.. und TR..ED

	Art. Nr.	Preis	ØA	ØB	ØC	H
TR-S10/15	22500	71,60	225	254	275	210
TR-S20/30/50	22510	85,00	330	359	380	210
TR-S70/100	22541	265,60	430	500	520	260
TR-S100/150	22542	392,00	570	640	660	330

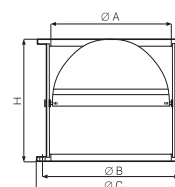

Dachventilatoren

1.4.9



Zubehör

für Serie TRM..E, TRM..E-V und TRT..E, TRT..E-V

Type	TRM 70 E 4P	TRT 70 E 4P	TRT 70 E 6P	TRT 100 E 4P	TRT 100 E 6P	TRT 100 E 8P	TRT 150 E 6P	TRT 150 E 8P	TRT 180 E 6P	TRT 210 E 6P
Grundrahmen Art. Nr. Preis	TR-CU 70/100 22539 49,60	TR-CU 70/100 22539 49,60	TR-CU 70/100 22539 49,60	TR-CU 70/100 22539 49,60	TR-CU 100/150 22540 54,00	TR-CU 100/150 22540 54,00	TR-CU 100/150 22540 54,00	TR-CU 100/150 22540 54,00	TR-CU 100/150 22540 54,00	TR-CU 100/150 22540 54,00
Schutzgitter saugseitig 70/100 Art. Nr. Preis	TR-G 70/100 22506 44,30	TR-G 70/100 22506 44,30	TR-G 70/100 22506 44,30	TR-G 70/100 22506 44,30	TR-G 100/150 22507 55,50	TR-G 100/150 22507 55,50	TR-G 100/150 22507 55,50	TR-G 100/150 22507 55,50	TR-G 100/150 22507 55,50	TR-G 100/150 22507 55,50
Rückschlagklappe Art. Nr. Preis	TR-S 70/100 22541 265,60	TR-S 70/100 22541 265,60	TR-S 70/100 22541 265,60	TR-S 70/100 22541 265,60	TR-S 100/150 22542 392,00	TR-S 100/150 22542 392,00	TR-S 100/150 22542 392,00	TR-S 100/150 22542 392,00	TR-S 100/150 22542 392,00	TR-S 100/150 22542 392,00
Ansaugdüse Art. Nr. Preis	TR-B 70/100 22508 161,80	TR-B 70/100 22508 161,80	TR-B 70/100 22508 161,80	TR-B 70/100 22508 161,80	TR-B 100/150 22509 184,20	TR-B 100/150 22509 184,20	TR-B 100/150 22509 184,20	TR-B 100/150 22509 184,20	TR-B 100/150 22509 184,20	TR-B 100/150 22509 184,20
Drehzahlregler 3-stufig 1-phasig, 230 V / 50 Hz Art. Nr. Preis	- - -	- - -	- - -	- - -	- - -	- - -	- - -	- - -	- - -	- - -
Drehzahlregler 3-stufig 3-phasig, 3x400 V / 50 Hz Art. Nr. Preis	- - -	IRT40 12927 518,30	IRT35 12924 419,20	IRT40 12927 518,30	IRT40 12927 518,30	IRT35 12924 419,20	IRT35 12924 419,20	IRT35 12924 419,20	IRT40 12927 518,30	- - -
Drehzahlsteller elektronisch stufenlos Art. Nr. Preis	IREM5 12932 205,90	IRET6 12934 604,90	IRET6 12934 604,90	IRET6 12934 604,90	IRET6 12934 604,90	IRET6 12934 604,90	IRET6 12934 604,90	IRET6 12934 604,90	- - -	- - -
Frequenzumformer 3-phasig, 3x400 V / 50 Hz Art. Nr. Preis	- - -	IRET INV2.2 12925 862,40	IRET INV2.2 12925 862,40	IRET INV5 12947 1.101,90	IRET INV2.2 12947 1.101,90	IRET INV2.2 12947 1.101,90	IRET INV5 12947 1.101,90	IRET INV5 12947 1.101,90	IRET INV8 12989 1.323,00	IRET INV8 12989 1.323,00

Drehzahlregler stufenlos

IREM. für 230 V/50 Hz, IRET. für 3 x 400 V/50 Hz

	Art. Nr.	Preis	A	B	C	D	E
IREM 3	12931	168,60	125	57	31	25	88
IREM 5	12932	205,90	125	57	31	25	88
IREM 9	12933	288,40	125	72	31	25	103
IRET 6	12934	604,90	175	78	27	30	108

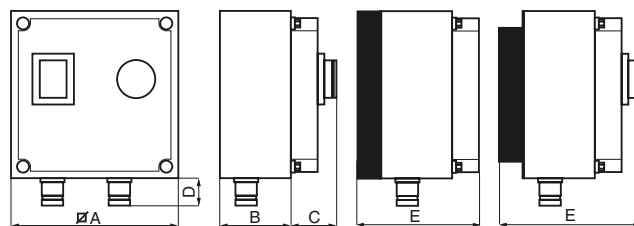

Drehzahlregler 3-stufig

IRM.. für 230 V/50 Hz, IRT.. für 3 x 400 V/50 Hz

	Art. Nr.	Preis	A	B	C	D
IRM 30	12921	267,90	200	254	99	128
IRM 40	12922	320,60	236	315	128	157
IRM 50	12928	296,90	236	315	128	157
IRT 15	12923	349,90	236	315	128	157
IRT 35	12924	419,20	236	315	128	157
IRT 40	12927	518,30	236	315	128	157

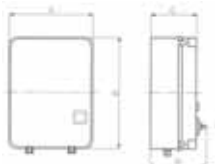

Frequenzumformer

IREM.. für 230 V/50 Hz, IRET.. für 3 x 400 V/50 Hz

	Art. Nr.	Preis	A	B	C	D
IREM INV1.4	12935	443,70	130	25	190	280
IREM INV4.2	12936	546,90	180	25	190	280
IREM INV7	12937	718,60	180	25	190	280
IRET INV1.2	12909	814,50	180	25	190	280
IRET INV2.2	12925	862,40	180	25	190	280
IRET INV5	12947	1.101,90	180	25	190	280
IRET INV8	12989	1.323,00	230	25	190	280

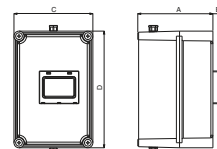



1.4.9

Dachventilatoren

NEU

Brandgasventilatoren für 400 °C / 120 min

Serie TRM-ED und TRT-ED horizontal oder vertikal ausblasend



TRM..ED und TRT..ED



TRM..ED-V und TRT..ED-V

- Dauereinsatztemperatur von -25 °C bis +90 °C
- Brandgastemperatur 400 °C für 120 Minuten nach EN12101-3*
- Gehäuse aus Metall mit Epoxydharzlackierung
- selbstreinigendes Aluminiumlaufrad
- Transportöse zum sicheren Transport an den Montageort
- Einphasenmodelle regelbar über optionalen Drehzahlregler**
- Dreiphasenmodelle schaltbar über optionalen Stern dreieckschalter oder Drehzahlregler**
- zur sicheren Befestigung ist das Gerät mit einem Sicherheitsseil ausgestattet das an der Tragekonstruktion befestigt werden kann.
- nicht geeignet für Montage auf Rohren unmittelbar über offenen Kaminen oder Brennern
- Motorisationsklasse H
- Schutzart IP55
- Ausführungsformen:

TRM..ED und TRT..ED mit horizontaler Ausblasung

TRM..ED-V und TRT..ED-V mit vertikaler Ausblasung

Modelle TRM ...		10ED 4P	15ED 4P	20ED 4P	30ED 4P	50ED 4P	70ED 4P
Art. Nr.		15039	15041	15043	15046	15048	15080
Preis		494,40	504,10	660,00	716,10	833,80	1.458,80
Modelle TRM ...		10ED-V 4P	15ED-V 4P	20ED-V 4P	30ED-V 4P	50ED-V 4P	70ED-V 4P
Art. Nr.		15160	15162	15164	15166	15168	15170
Preis		789,50	805,00	1.054,00	1.072,00	1.165,00	1.893,00
Fördermenge	m³/h	1000	1400	2200	3100	4500	5800
max. Druck	Pa	100	130	230	280	380	500
Spannung 50 Hz	V	230	230	230	230	230	230
Nennstrom	A	0,46	0,58	1,18	1,78	3,10	4,3
Leistungsaufnahme	W	110	140	270	420	720	1200
Drehzahl	U/min	1395	1315	1375	1285	1288	1415
Schallpegel (3 m)	dB(A)	56	58,5	59	67	72,5	77

Modelle TRT ...		10ED 4P	15ED 4P	20ED 4P	30ED 4P	50ED 4P	70ED 4P	70ED 6P
Art. Nr.		15040	15042	15045	15047	15049	15081	15082
Preis		501,80	496,70	620,30	681,70	772,20	1.403,20	1.587,40
Modelle TRT ...		10ED-V 4P	15ED-V 4P	20ED-V 4P	30ED-V 4P	50ED-V 4P	70ED-V 4P	70ED-V 6P
Art. Nr.		15161	15163	15165	15167	15169	15171	15172
Preis		801,30	793,20	1.021,50	1.054,60	1.117,60	1.820,70	2.059,70
Fördermenge	m³/h	890	1100	1800	2555	3800	5300	5300
max. Druck	Pa	105	170	265	320	385	435	275
Spannung 50 Hz	V	3x400	3x400	3x400	3x400	3x400	3x400	3x400
Nennstrom	A	0,24	0,27	0,53	0,75	1,21	2,0	1,3
Leistungsaufnahme	W	100	130	270	420	690	1090	600
Drehzahl	U/min	1400	1345	1384	1355	1380	1440	950
Schallpegel (3 m)	dB(A)	56	58,5	59	67	72,5	77	74

Modelle TRT		100ED 4P	100ED 6P	100ED 8P	150ED 6P	150ED 8P	180ED 6P	210ED 6P
Art. Nr.		15083	15084	15085	15086	15087	15919	15920
Preis		1.587,40	2.095,20	2.309,70	2.266,80	2.538,50	2.656,60	2.842,50
Modelle TRT		100ED-V 4P	100ED-V 6P	100ED-V 8P	150ED-V 6P	150ED-V 8P	180ED-V 6P	210ED-V 6P
Art. Nr.		15173	15174	15175	15176	15177	15178	15179
Preis		1.980,50	2.613,90	2.881,50	2.714,90	3.040,30	3.228,80	3.367,00
Fördermenge	m³/h	8300	8550	8200	11000	11600	16500	18000
max. Druck	Pa	635	375	280	475	360	775	785
Spannung 50 Hz	V	3x400	3x400	3x400	3x400	3x400	3x400	3x400
Nennstrom	A	4,9	2,4	2,0	3,4	3,0	6,11	6,42
Leistungsaufnahme	W	1950	1130	860	1930	1510	3200	3460
Drehzahl	U/min	1420	950	715	930	715	950	950
Schallpegel (3 m)	dB(A)	84	77	71	80	74	83	84

Dachventilatoren

1.4.9



Abmessungen



Serie TRM-ED und TRT-ED horizontal ausblasend

Abmessungen

Modell	Flügel	ø A	B	C	D	E	F	G	H	ø L	ø M	ø N	Flügel	kg
TRM 10 ED 4P	280x101,5	600	410	357	309	166	38	26,5	513	183	187,5	280	101,5	18,5
TRT 10 ED 4P	280x101,5	600	410	357	309	166	38	26,5	513	183	187,5	280	101,5	18,5
TRM 15 ED 4P	315x101,5	600	410	357	309	166	38	26,5	513	206	211	315	101,5	19
TRT 15 ED 4P	315x101,5	600	410	357	309	166	38	26,5	513	206	211	315	101,5	19
TRM 20 ED 4P	355x125	780	550	500	397	226	38	25	661	231	236,5	355	125	33
TRT 20 ED 4P	355x125	780	550	500	397	226	38	25	661	231	236,5	355	125	33
TRM 30 ED 4P	400x140	780	550	500	397	226	38	25	661	260	265,5	400	140	35
TRT 30 ED 4P	400x140	780	550	500	397	226	38	25	661	260	265,5	400	140	35
TRM 50 ED 4P	450x160	780	550	500	397	243	38	25	678	292	298	450	160	40
TRT 50 ED 4P	450x160	780	550	500	397	243	38	25	678	292	298	450	160	40
TRM 70 ED 4P	500x160	1015	830	750	449	283	38	40	770	328	335	504	160	80
TRT 70 ED 4P	500x160	1015	830	750	449	283	38	40	770	328	335	504	160	78
TRT 70 ED 6P	560x180	1015	830	750	449	283	38	40	770	365	375	562	180	81
TRT 100 ED 4P	560x180	1015	830	750	449	283	38	40	770	365	375	562	180	81,5
TRT 100 ED 6P	630x224	1165	980	900	605	383	38	40	1026	415	421	635	224	114
TRT 100 ED 8P	710x224	1165	980	900	605	383	38	40	1026	415	472	715	224	124
TRT 150 ED 6P	710x250	1165	980	900	605	383	38	40	1026	465	472	715	250	125
TRT 150 ED 8P	800x250	1165	980	900	605	383	38	40	1026	520	529	805	250	129
TRT 180 ED 6P	800x250	1165	980	900	605	383	38	40	1026	520	529	805	250	220
TRT 210 ED 6P	800x250	1165	980	900	605	383	38	40	1026	520	529	805	250	222

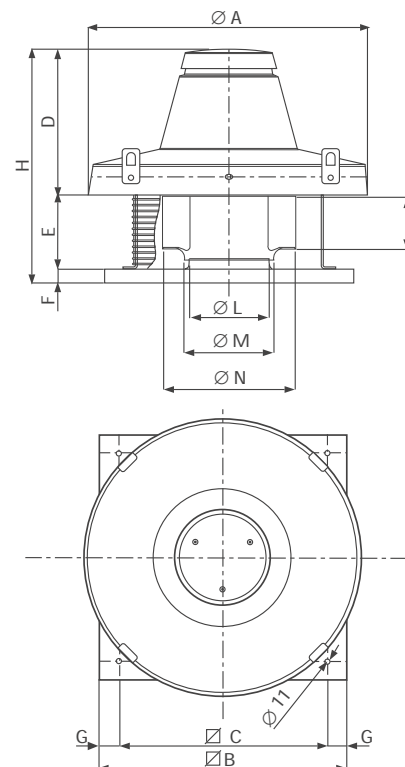

Serie TRM-ED-V und TRT-ED-V vertikal ausblasend

Abmessungen

Modell	ø A	B	C	D	E	F	G	H	ø L	ø M	ø N	kg
TRM 10 ED-V 4P	652	410	357	440	328	38	26,5	538	183	187,5	284	32
TRT 10 ED-V 4P	652	410	357	440	328	38	26,5	538	183	187,5	284	33
TRM 15 ED-V 4P	652	410	357	440	328	38	26,5	538	206	211	319	61
TRT 15 ED-V 4P	652	410	357	440	328	38	26,5	538	206	211	319	63
TRM 20 ED-V 4P	907	550	500	580	432	38	25	653	231	236,5	359	68
TRT 20 ED-V 4P	907	550	500	580	432	38	25	653	231	236,5	359	130
TRM 30 ED-V 4P	907	550	500	580	432	38	25	653	260	265,5	404	33
TRT 30 ED-V 4P	907	550	500	580	432	38	25	653	260	265,5	404	33
TRM 50 ED-V 4P	907	550	500	580	432	38	25	669	292	298	454	61
TRT 50 ED-V 4P	907	550	500	580	432	38	25	669	292	298	454	63
TRM 70 ED-V 4P	1144	830	750	860	791	38	40	743	328	335	504	68
TRT 70 ED-V 4P	1144	830	750	860	491	38	40	743	328	335	504	128
TRT 70 ED-V 6P	1144	830	750	860	491	38	40	743	365	375	564	131
TRT 100 ED-V 4P	1144	830	750	860	491	38	40	743	365	375	564	132
TRT 100 ED-V 6P	1462	980	900	1010	595	38	40	923	415	421	635	207
TRT 100 ED-V 8P	1462	980	900	1010	595	38	40	923	465	472	715	217
TRT 150 ED-V 6P	1462	980	900	1010	595	38	40	923	465	472	715	218
TRT 150 ED-V 8P	1462	980	900	1010	595	38	40	923	520	529	805	222
TRT 180 ED-V 6P	1462	980	900	1010	595	38	40	923	520	529	805	220
TRT 210 ED-V 6P	1462	980	900	1010	595	38	40	923	520	529	805	222

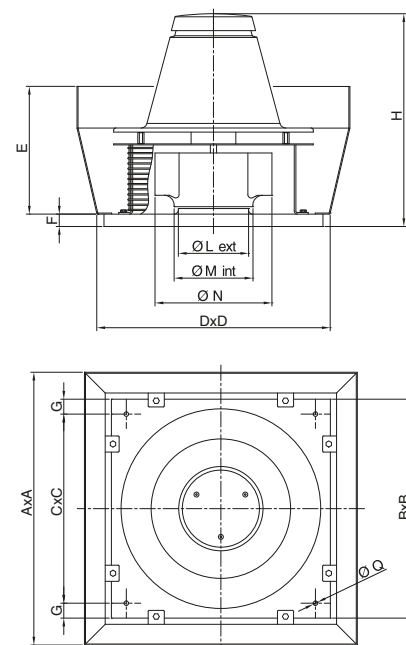



1.4.9

Dachventilatoren

Leistungsdiagramme

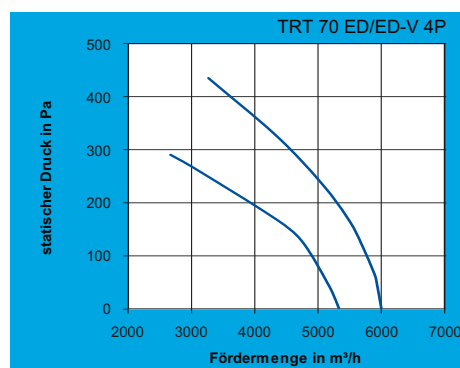
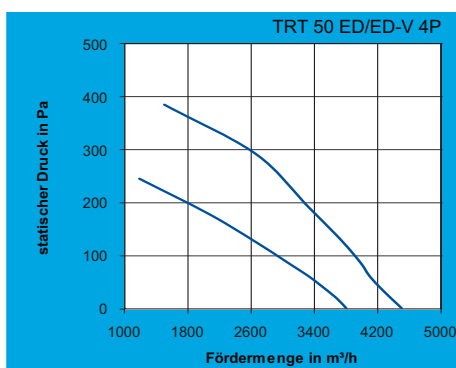
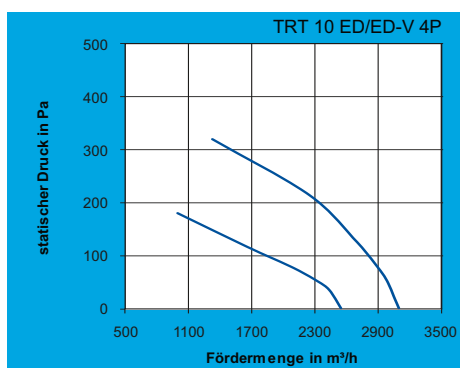
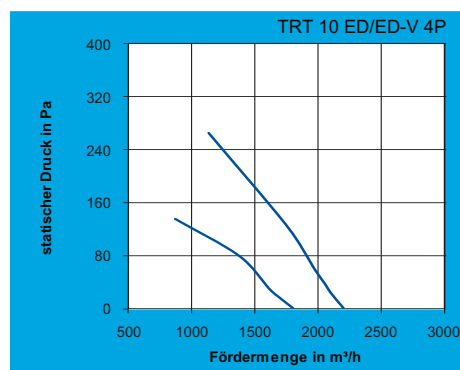
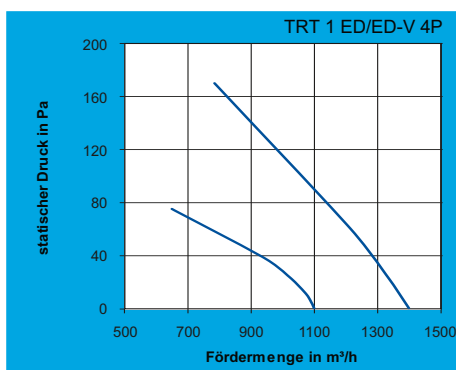
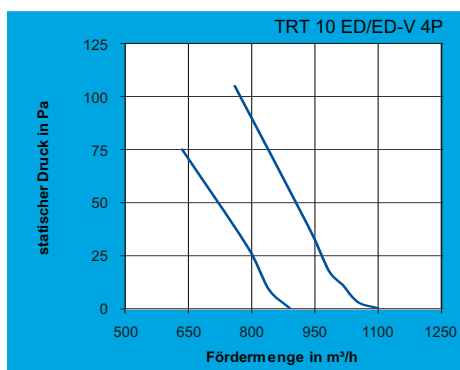
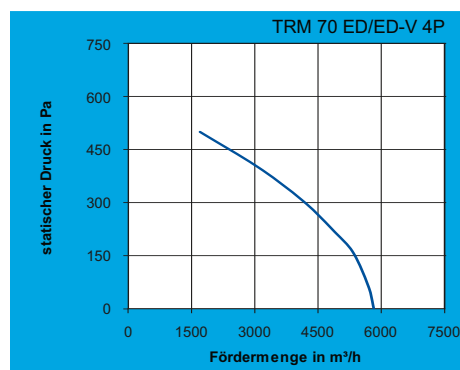
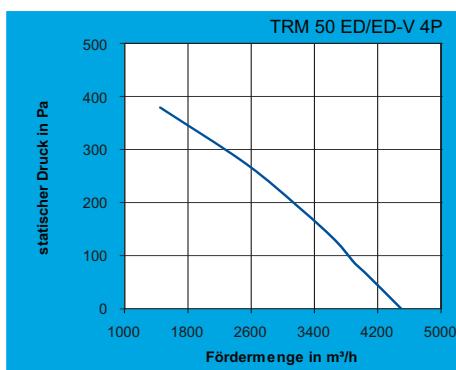
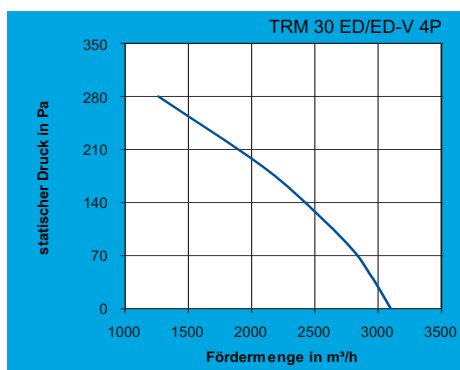
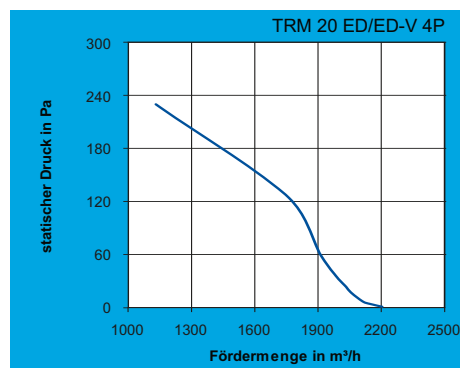
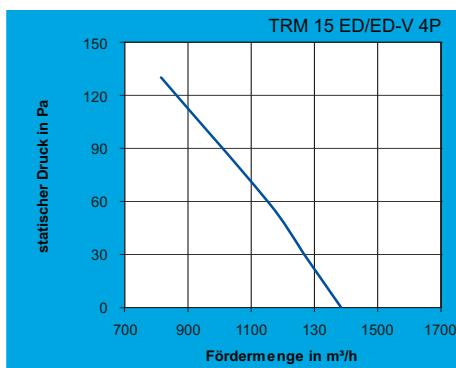
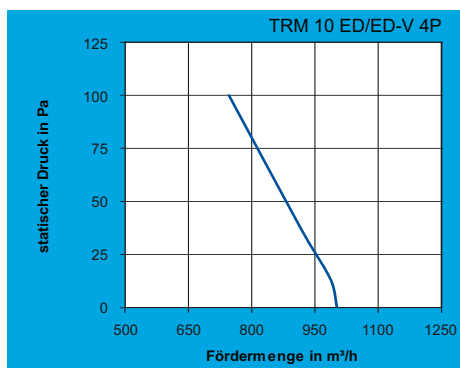

Dachventilatoren

1.4.9



für TRM...ED, TRM...ED-V, TRT...ED und TRT...ED-V

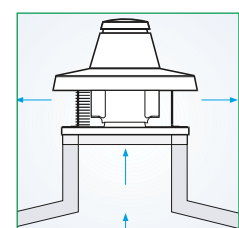
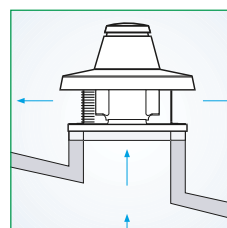
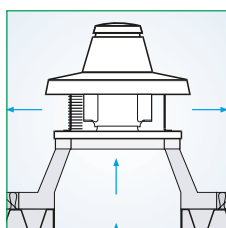
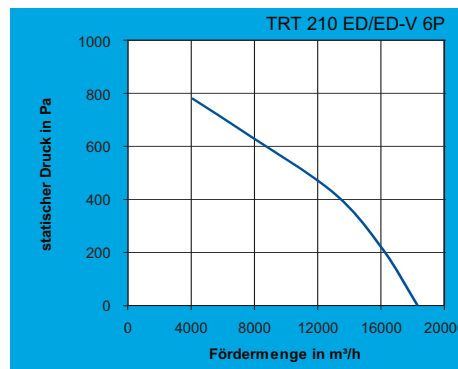
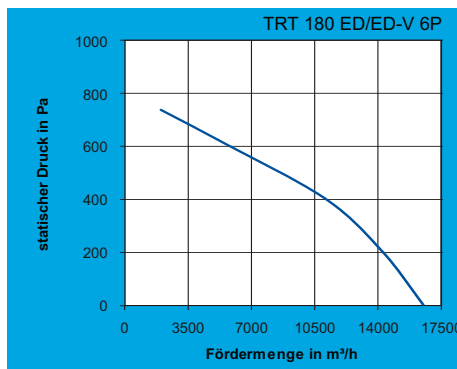
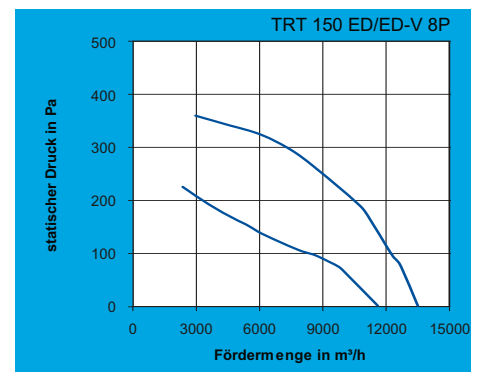
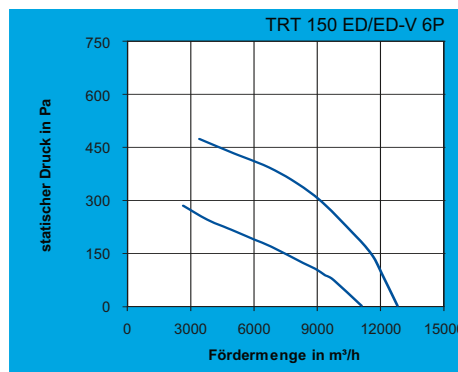
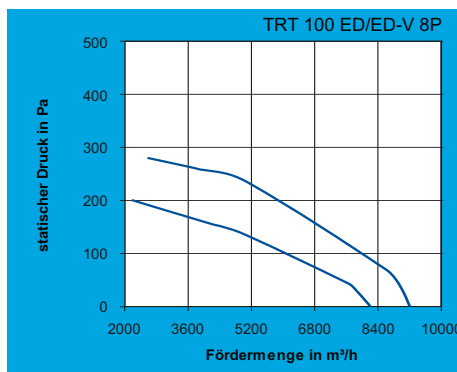
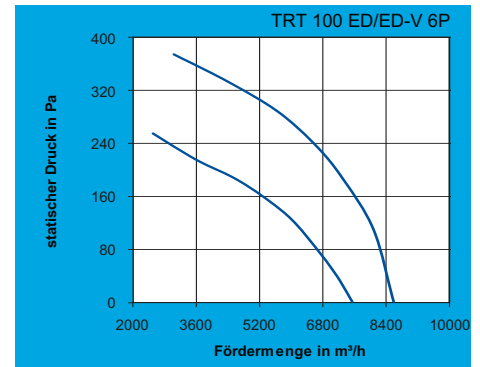
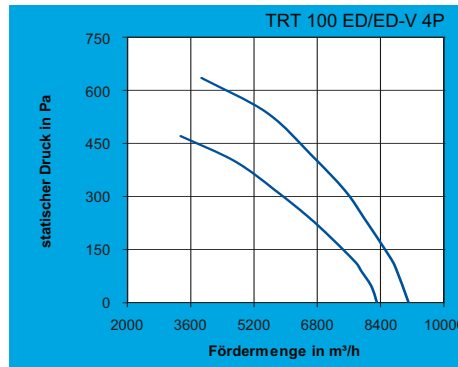
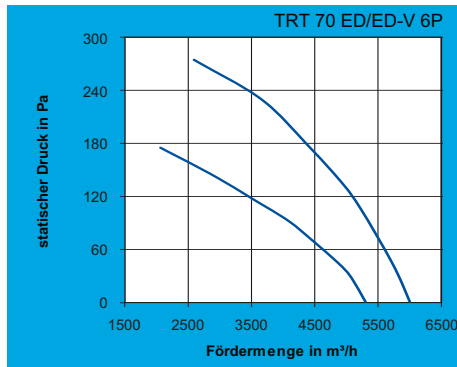



1.4.9

Dachventilatoren

Zubehör

für Serie TRM..ED, TRM..ED-V und TRT..ED, TRT..ED-V

Type	TRM 10 ED 4P	TRT 10 ED 4P	TRM 15 ED 4P	TRT 15 ED 4P	TRM 20 ED 4P	TRT 20 ED 4P	TRM 30 ED 4P	TRT 30 ED 4P	TRM 50 ED 4P	TRT 50 ED 4P
Grundrahmen Art. Nr. Preis	TR-CU 10/15 22511 40,80	TR-CU 10/15 22511 40,80	TR-CU 10/15 22511 40,80	TR-CU 10/15 22511 40,80	TR-CU 20/30/50 22512 44,40	TR-CU 20/30/50 22512 44,40	TR-CU 20/30/50 22512 44,40	TR-CU 20/30/50 22512 44,40	TR-CU 20/30/50 22512 44,40	TR-CU 20/30/50 22512 44,40
Schutzgitter saugseitig Art. Nr. Preis	TR-ED G 10/15 22700 12,80	TR-ED G 10/15 22700 12,80	TR-ED G 10/15 22700 12,80	TR-ED G 10/15 22700 12,80	TR-ED G 20/30/50 22710 17,20	TR-ED G 20/30/50 22710 17,20	TR-ED G 20/30/50 22710 17,20	TR-ED G 20/30/50 22710 17,20	TR-ED G 20/30/50 22710 17,20	TR-ED G 20/30/50 22710 17,20
2-Stufen Schalter Art. Nr. Preis	- - -	TR-CVT 22910 172,30	- - -	TR-CVT 22910 172,30	- - -	TR-CVT 22910 172,30	- - -	TR-CVT 22910 172,30	- - -	TR-CVT 22910 172,30
Drehzahlregler 3-stufig 1-phasig, 230 V / 50 Hz Art. Nr. Preis	IRM30 12921 267,90	- - -	IRM30 12921 267,90	- - -	IRM40 12922 320,60	- - -	IRM40 12922 320,60	- - -	IRM50 12928 320,60	- - -
Drehzahlregler 3-stufig 3-phasig, 3x400 V / 50 Hz Art. Nr. Preis	- - -	IRT15 12923 349,90	- - -	IRT15 12923 349,90	- - -	IRT15 12923 349,90	- - -	IRT35 12924 419,20	- - -	IRT35 12924 419,20
Drehzahlsteller elektronisch stufenlos Art. Nr. Preis	IREM3 12931 168,60	- - -	IREM3 12931 168,60	- - -	IREM3 12931 168,60	- - -	IREM3 12931 168,60	- - -	IREM5 12932 205,90	- - -
Frequenzumformer 3-phasig, 3x400 V / 50 Hz Art. Nr. Preis	- - -	IRET INV1.2 12909 814,50	- - -	IRET INV1.2 12909 814,50	- - -	IRET INV1.2 12909 814,50	- - -	IRET INV1.2 12909 814,50	- - -	IRET INV2.2 12925 862,40

Zubehör für TR

Grundrahmen für TR.. und TR..ED

	Art. Nr.	Preis	A	B
TR-CU 10/15	22511	40,80	357	401
TR-CU20/30/50	22512	44,40	500	541
TR-CU70/100	22539	49,60	750	791
TR-CU100/150	22540	54,00	900	941

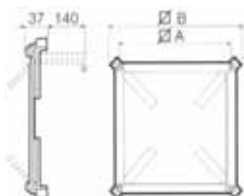

2-stufen Drehzahlregler für TR.. und TR..ED

	Art. Nr.	Preis	A	Pos.	IP
TR-CVT	22910	172,30	92	0 [^] Δ	65

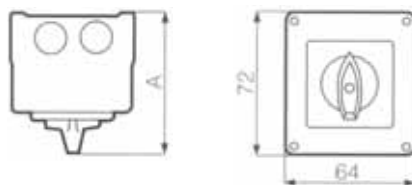

Schutzgitter für TR.. und TR..ED

Saugseitig

	Art. Nr.	Preis	ØA	ØB
TR-G10/15	22700	12,80	222	254
TR-G20/30/50	22710	17,20	318	359
TR-G70/100	22506	44,30	423	500
TR-G100/150	22507	55,50	563	640

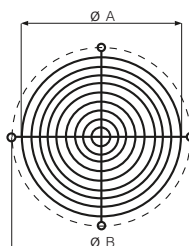

Dachventilatoren

1.4.9



Zubehör

für Serie TRM..ED, TRM..ED-V und TRT..ED, TRT..ED-V

Type	TRM 70 ED 4P	TRT 70 ED 4P	TRT 70 ED 6P	TRT 100 ED 4P	TRT 100 ED 6P	TRT 100 ED 8P	TRT 150 ED 6P	TRT 150 ED 8P	TRT 180 ED 6P	TRT 210 ED 6P
Grundrahmen Art. Nr. Preis	TR-CU 70/100 22539 49,60	TR-CU 70/100 22539 49,60	TR-CU 70/100 22539 49,60	TR-CU 70/100 22539 49,60	TR-CU 100/150 22540 54,00	TR-CU 100/150 22540 54,00	TR-CU 100/150 22540 54,00	TR-CU 100/150 22540 54,00	TR-CU 100/150 22540 54,00	TR-CU 100/150 22540 54,00
Schutzgitter saugseitig Art. Nr. Preis	TR-ED G 70/100 22506 44,30	TR-ED G 70/100 22506 44,30	TR-ED G 70/100 22506 44,30	TR-ED G 70/100 22506 44,30	TR-ED G 100/150 22507 55,50	TR-ED G 100/150 22507 55,50	TR-ED G 100/150 22507 55,50	TR-ED G 100/150 22507 55,50	TR-ED G 100/150 22507 55,50	TR-ED G 100/150 22507 55,50
2-Stufen Schalter Art. Nr. Preis	- - -	TR-CVT 22910 172,30	TR-CVT 22910 172,30	TR-CVT 22910 172,30	TR-CVT 22910 172,30	TR-CVT 22910 172,30	TR-CVT 22910 172,30	TR-CVT 22910 172,30	TR-CVT 22910 172,30	TR-CVT 22910 172,30
Drehzahlregler 3-stufig 1-phasig, 230 V / 50 Hz Art. Nr. Preis	- - -	- - -	- - -	- - -	- - -	- - -	- - -	- - -	- - -	- - -
Drehzahlregler 3-stufig 3-phasig, 3x400 V / 50 Hz Art. Nr. Preis	- - -	IRT40 12927 518,30	IRT35 12924 419,20	IRT40 12927 518,30	IRT40 12927 518,30	IRT35 12924 419,20	- - -	IRT40 12927 518,30	- - -	- - -
Drehzahlsteller elektronisch stufenlos Art. Nr. Preis	IREM9 12933 288,40	IRET6 12934 604,90	IRET6 12934 604,90	IRET6 12934 604,90	IRET6 12934 604,90	IRET6 12934 604,90	IRET6 12934 604,90	IRET6 12934 604,90	- - -	- - -
Frequenzumformer 3-phasig, 3x400 V / 50 Hz Art. Nr. Preis	- - -	IRET INV2.2 12925 862,40	IRET INV2.2 12925 862,40	IRET INV5 12947 1.101,90	IRET INV5 12947 1.101,90	IRET INV2.2 12925 862,40	IRET INV5 12947 1.101,90	IRET INV5 12947 1.101,90	IRET INV8 12989 1.323,00	IRET INV8 12989 1.323,00

Drehzahlregler stufenlos

IREM. für 230 V/50 Hz, IRET. für 3 x 400 V/50 Hz

	Art. Nr.	Preis	A	B	C	D	E
IREM 3	12931	168,60	125	57	31	25	88
IREM 5	12932	205,90	125	57	31	25	88
IREM 9	12933	288,40	125	72	31	25	103
IRET 6	12934	604,90	175	78	27	30	108

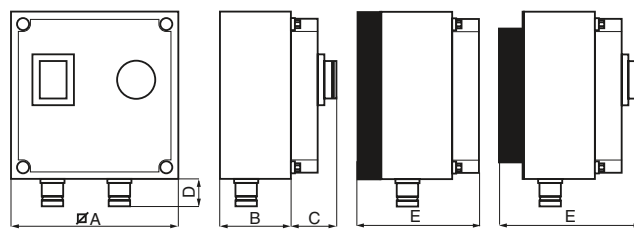

Drehzahlregler 3-stufig

IRM.. für 230 V/50 Hz, IRT.. für 3 x 400 V/50 Hz

	Art. Nr.	Preis	A	B	C	D
IRM 30	12921	267,90	200	254	99	128
IRM 40	12922	320,60	236	315	128	157
IRM 50	12928	296,90	236	315	128	157
IRT 15	12923	349,90	236	315	128	157
IRT 35	12924	419,20	236	315	128	157
IRT 40	12927	518,30	236	315	128	157



Frequenzumformer

IRET.. für 3 x 400 V/50 Hz

	Art. Nr.	Preis	A	B	C	D
IRET INV1.2	12909	814,50	180	25	190	280
IRET INV2.2	12925	862,40	180	25	190	280
IRET INV5	12947	1.101,90	180	25	190	280
IRET INV8	12989	1.323,00	230	25	190	280

